

Uni-polar, Hall-Effect Switch IC with Self-diagnosis

1 Product Description

The MT891X family is a hall-effect switch IC with self diagnosis produced by BCD technology with both high performance and high reliability. The Hall IC internally includes an on-chip Hall voltage generator, a voltage regulator for operation with supply voltage of 2.7V to 24V, temperature compensation circuitry, small-signal amplifier, Hall IC with dynamic offset cancellation system, Schmitt trigger and two open drain output, all in a single package.

The MT891X family offers self-diagnosis function during the sensor power-on. This allows the user to check the functionality of the whole signal path in response to BOP and BRP, as well as the wire connections of the sensor IC.

The MT891X family provides SOT-23 & SOT-23-6L for surface mount to customers. All packages are RoHS compliant.

2 Features

- AEC-Q100 Automotive Qualified
- 2.7~24V Operating V_{DD} Range
- -40°C~150°C Operating Temperature
- Package Option:
SOT-23
SOT-23-6L
- Magnetic Sensitivity Option:
MT8911 (BOP=140Gs, BRP=105Gs)
MT8912 (BOP=255Gs, BRP=210Gs)
- Self-diagnosis
- -30V Reversed Power Supply Protection
- Output Over Current Protection
- RoHS Compliant: (EU)2015/863
- ASIL-B ready

3 Product Overview of MT891X

Part No.	Description
MT891XAT	SOT-23, tape & reel (3000pcs/bag)
MT891XAT-Dual	SOT-23-6L, tape & reel (3000pcs/bag)



4 Applications

- Automotive, Home appliances, Industrial
- Speed Detection
- Position Detection
- Solid-State Switch
- Proximity Switch

5 Pin Configuration and Functions

SOT-23-6L	No.	Description
OUT1	1	V _{OUT1}
NC	2	Unconnected
OUT2	3	V _{OUT2}
V _{DD}	4	Power Supply
GND	5	Ground
GND	6	Ground

SOT-23	No.	Description
V _{DD}	1	Power Supply
OUT	2	V _{OUT}
GND	3	Ground

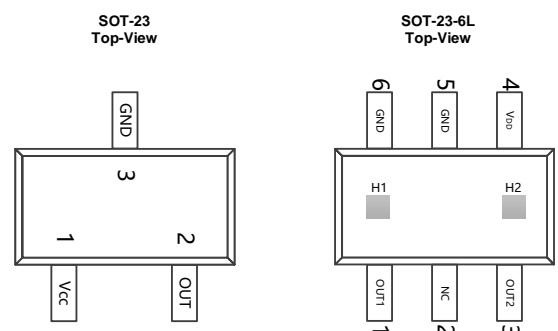

Figure.1 Pin Configuration & Functions

Table of Contents

1	Product Description.....	1
2	Features.....	1
3	Product Overview of MT891X	1
4	Applications.....	1
5	Pin Configuration and Functions.....	1
6	Switching Function.....	3
	6.1 Definition of Switching Function.....	3
	6.2 Function Description.....	3
	6.3 Feature Description.....	3
7	Functional Block Diagram.....	4
	6.1 Diagnostics Coverage Block Diagram	4
8	Electrical and Magnetic Characteristics.....	4
	7.1 Absolute Maximum Ratings.....	4
	7.2 Electrical Specifications	5
	7.3 Typical Output Waveform	5
	7.4 Magnetic Characteristics	6
	7.5 ESD Rating	6
	7.6 Characteristics Performance	6
8	Typical Application Circuit.....	8
9	Self-diagnosis.....	8
10	Package Material Information.....	10
	10.1 SOT-23 Package Information.....	10
	10.2 SOT-23-6L Package Information.....	11
11	Copy Rights and Disclaimer.....	12

Reversion History

1	Version 1.0	Original Version
2	Version 1.1	Update Switching Function
3	Version 1.2	Update the Package Information

6 Switching Function

6.1 Definition of Switching Function

Figure.2 shows the device functionality and hysteresis

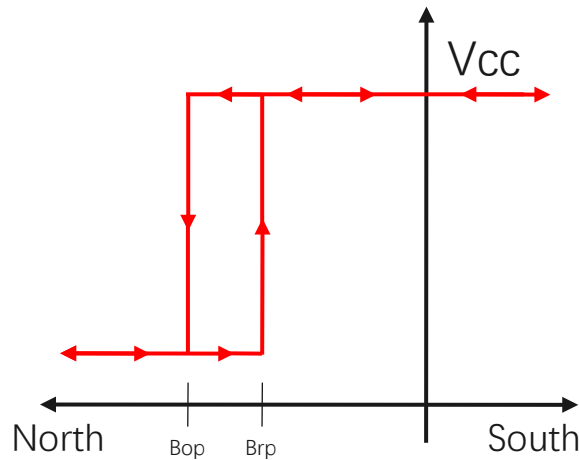

Figure.2 Switching Function Uni-polar (North)
SOT-23 & SOT-23-6L

6.2 Function Description

B_{OP}: Operating Point, Magnetic flux density applied on the branded side of the package which turns the output driver ON ($V_{OUT}=Low$)

B_{RP}: Releasing Point, Magnetic flux density applied on the branded side of the package which turns the output driver OFF ($V_{OUT}=High$)

B_{HYST}: Hysteresis Window, $|B_{OP} - B_{RP}|$

Devices that have a lower magnetic threshold ($V_{OUT}=High$) detect magnets at a farther distance. Higher thresholds ($V_{OUT}=Low$) generally require a closer distance or larger magnet.

6.3 Feature Description

The MT891X device is sensitive to the magnetic field component that is perpendicular to the top of the package

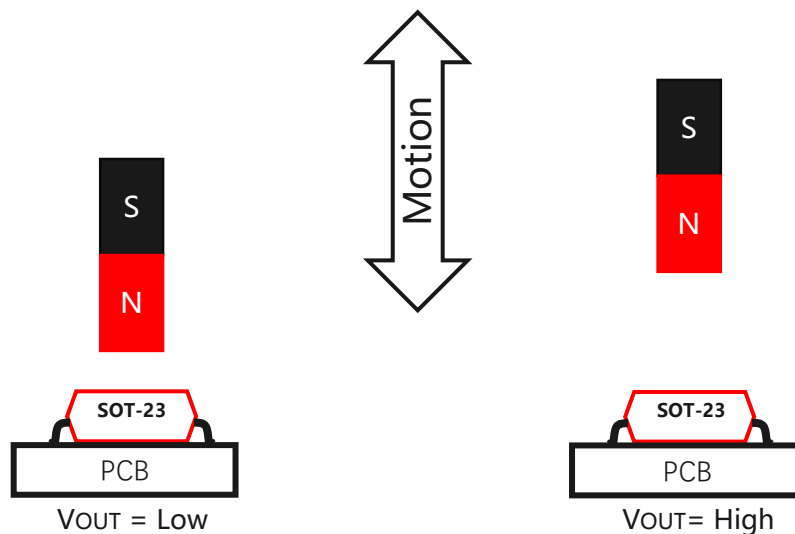

Figure.3 Flux Direction Polarity

7 Functional Block Diagram

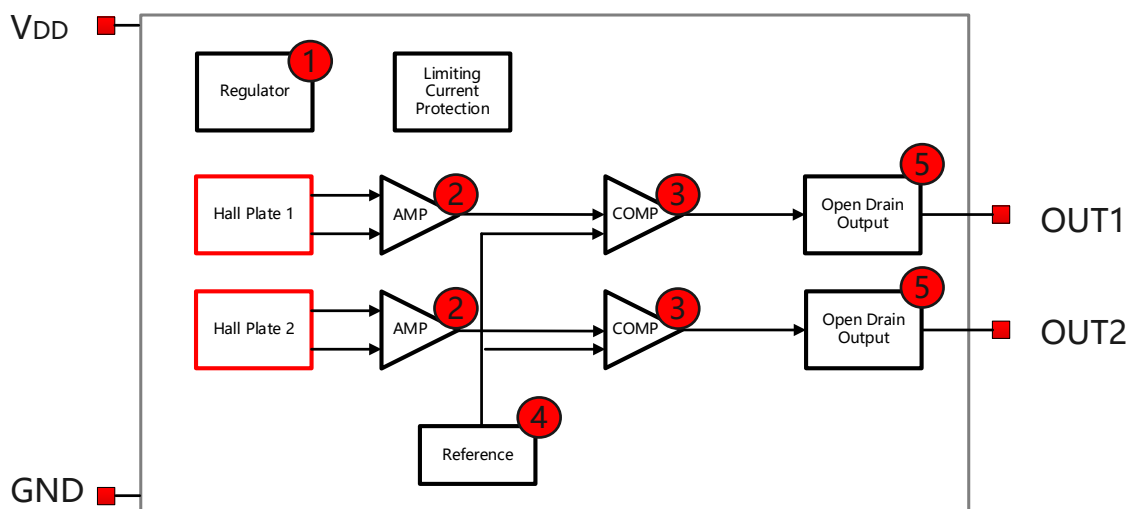

Figure.4 Functional Block Diagram (MT8911AT-Dual as example)

7.1 Diagnostics Coverage Block Diagram

No	Feature	Definition
1	Regulator	Regulator voltage for normal operation
2	AMP	Signal Amplifier
3	COMP	Comparator
4	Reference	Reference
5	Open Drain Output	Output

8 Electrical and Magnetic Characteristics

8.1 Absolute Maximum Ratings

Absolute maximum ratings are limited values to be applied individually, and beyond which the serviceability of the circuit may be impaired. Functional operability is not necessarily implied. Exposure to absolute maximum rating conditions for an extended period of time may affect device reliability.

Symbol	Parameters	Min	Max	Units
V _{DD}	Supply Voltage	-	30	V
V _{RDD}	Reverse Battery Voltage	-30	-	V
V _{OUT}	Output Voltage	-0.7	30	V
I _{OUT}	Continuous Output Current	-	40	mA
T _A	Operating Ambient Temperature	-40	150	°C
T _S	Storage Temperature	-50	150	°C
T _J	Junction Temperature	-	165	°C
B	Magnetic Flux Density	No Limit		Gs

8.2 Electrical Specifications

At $T_A = -40 \sim 150 \text{ }^\circ\text{C}$, $V_{DD} = 2.7\text{V} \sim 24\text{V}$ (unless otherwise specified)

Symbol	Parameters	Test Condition	Min	Typ	Max	Unit
V_{DD}	Supply Voltage	Operating	2.7	-	24	V
I_{DD}	Supply Current	$F_s = 100\text{KHz}$	-	4.5	7.5	mA
I_{OCP}	Short Circuit Protection Current	$B > B_{OP}$, $V_{OUT} = V_{DD}$	-	30	-	mA
V_{DSON}	Output Saturation Voltage	$I_{OUT} = 10\text{mA}$, $B > B_{OP}$	-	-	0.4	V
I_{OFF}	Output Leakage Current	$V_{OUT} = 24\text{V}$, $ B < BRP $	-	-	10	μA
T_R & T_F	Output Rise & Fall Time	$R_L = 1\text{K}\Omega$, $C_L = 20\text{pF}$	-	-	1.0	μs
$T_{PO}^{(1)}$	Power on Time	$dV_{DD}/dt > 5\text{V}/\mu\text{s}$ $B > B_{OP(MAX)}$	-	20	30	μs
F_s	Sampling Frequency		-	100	-	KHz
R_{TH}	Thermal Resistance of SOT-23 & SOT-23-6L		-	301	-	$^\circ\text{C}/\text{W}$

Notes:

(1) TPO here is defined when self-diagnosis is disabled. If self-diagnosis is enabled, please refer to the t_{edge3} in Part 9 (Self-diagnosis)

8.3 Typical Output Waveform

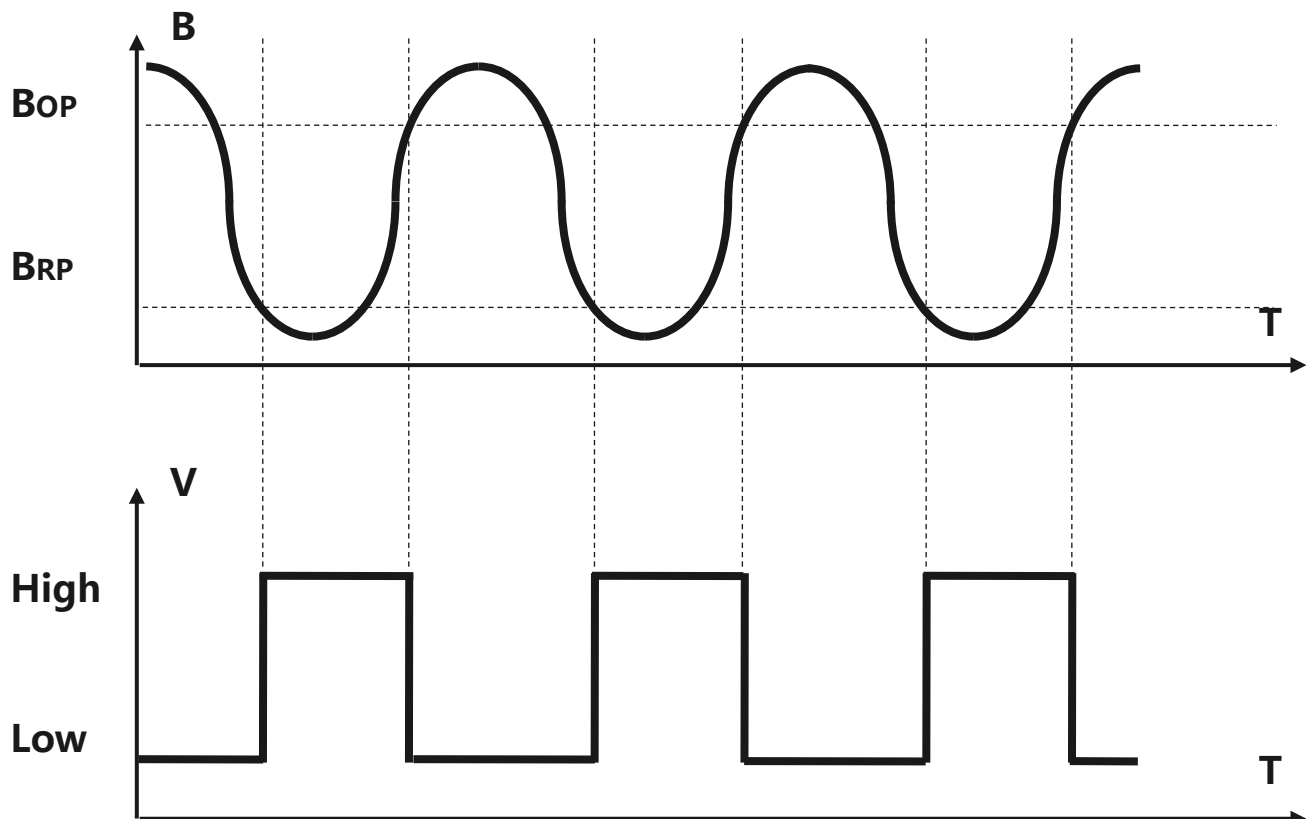

Figure.5 Digital Output vs. Magnetic Flux Density (MT8911AT as example)

8.4 Magnetic Characteristics

At $V_{DD}=2.7V\sim 24V$ (unless otherwise specified)

Part No.	Symbol	Min	Typ	Max	Unit
MT8911 Series	BOP, $T_A = 25^\circ C, V_{DD} > 3V$	110	140	170	Gs
	BRP, $T_A = 25^\circ C, V_{DD} > 3V$	75	105	135	Gs
	BHYST, $T_A = 25^\circ C, V_{DD} > 3V$	20	35	50	Gs
	BOP, $T_A = 25^\circ C, V_{DD} \leq 3V$	110	150	180	Gs
	BRP, $T_A = 25^\circ C, V_{DD} \leq 3V$	75	115	145	Gs
	BHYST, $T_A = 25^\circ C, V_{DD} \leq 3V$	20	40	55	Gs
MT8912 Series	BOP, $T_A = 25^\circ C, V_{DD} > 3V$	210	255	300	Gs
	BRP, $T_A = 25^\circ C, V_{DD} > 3V$	165	210	255	Gs
	BHYST, $T_A = 25^\circ C, V_{DD} > 3V$	30	45	60	Gs
	BOP, $T_A = 25^\circ C, V_{DD} \leq 3V$	210	275	320	Gs
	BRP, $T_A = 25^\circ C, V_{DD} \leq 3V$	165	230	275	Gs
	BHYST, $T_A = 25^\circ C, V_{DD} \leq 3V$	30	50	65	Gs

8.5 ESD Ratings

Symbol	Reference	Values	Unit
V_{ESD}	Human-body model (HBM)	AEC-Q100-002	Class H3 Grade
	Charged-device model (CDM)	AEC-Q100-011	Class C3 Grade

8.6 Characteristics Performance

MT8911 Series

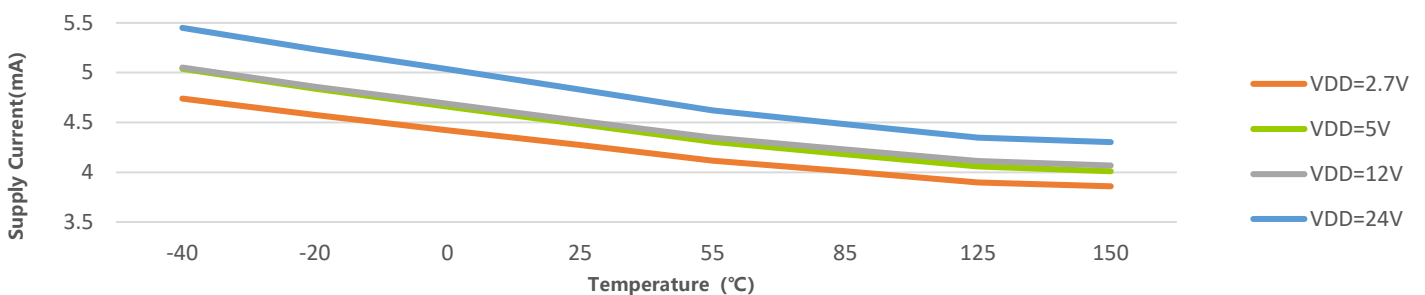

Figure.6 Supply Current vs. Temperature & V_{DD}

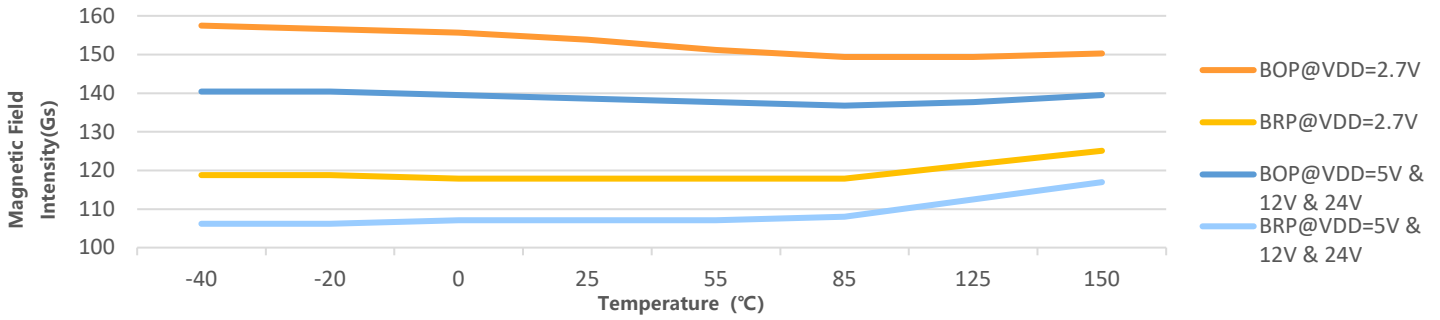

Figure.7 Magnetic Characteristics vs. Temperature & V_{DD} (B_{OP} & B_{RP})

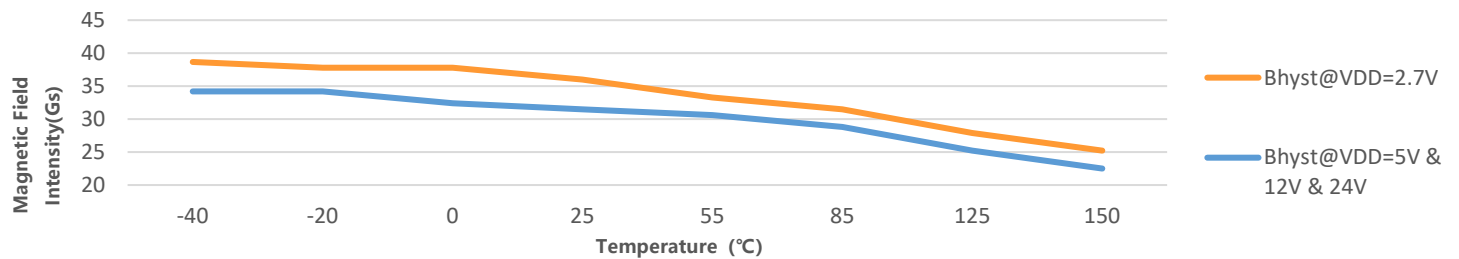

Figure.8 Magnetic Characteristics vs. Temperature & V_{DD} (B_{HYST})

MT8912 Series

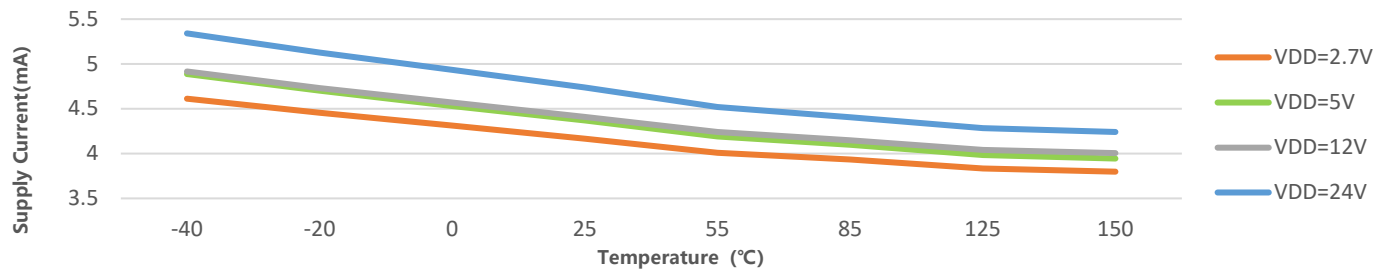

Figure.9 Supply Current vs. Temperature & V_{DD}

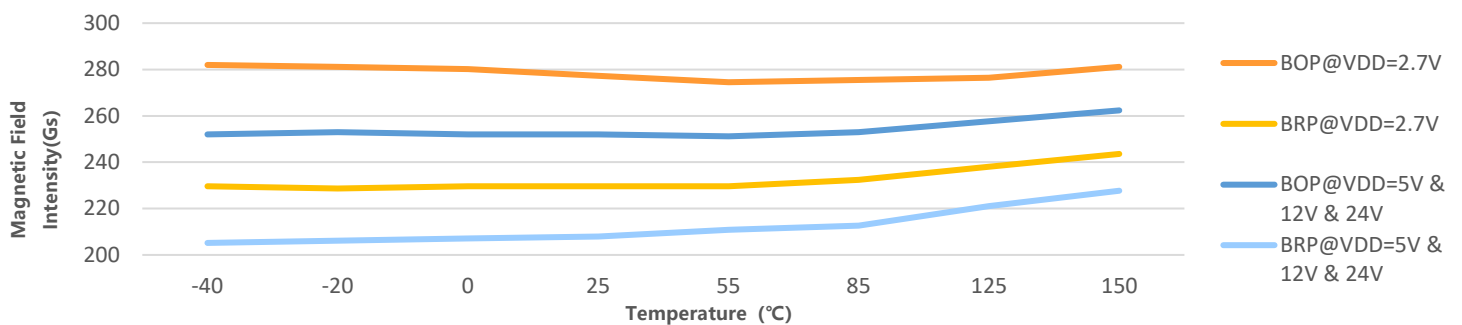

Figure.10 Magnetic Characteristics vs. Temperature & V_{DD} (B_{OP} & B_{RP})

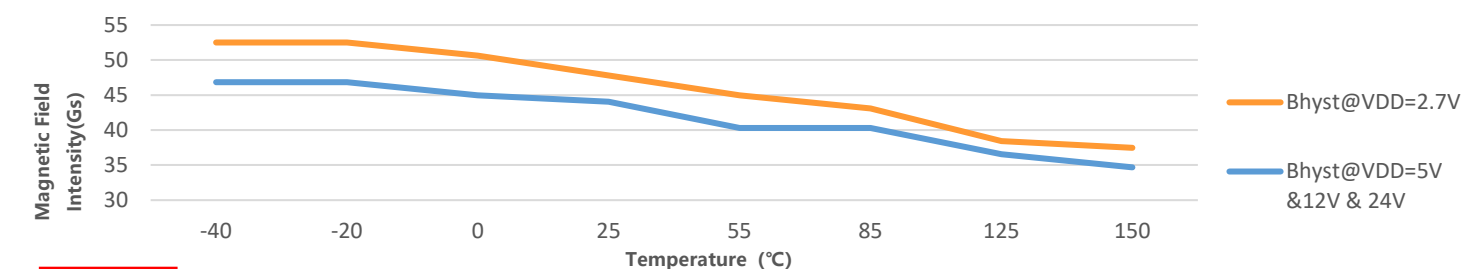

Figure.11 Magnetic Characteristics vs. Temperature & V_{DD} (B_{HYST})

9 Typical Application Circuit

Note: Recommended value for R_L is 5KOhms to 20KOhms

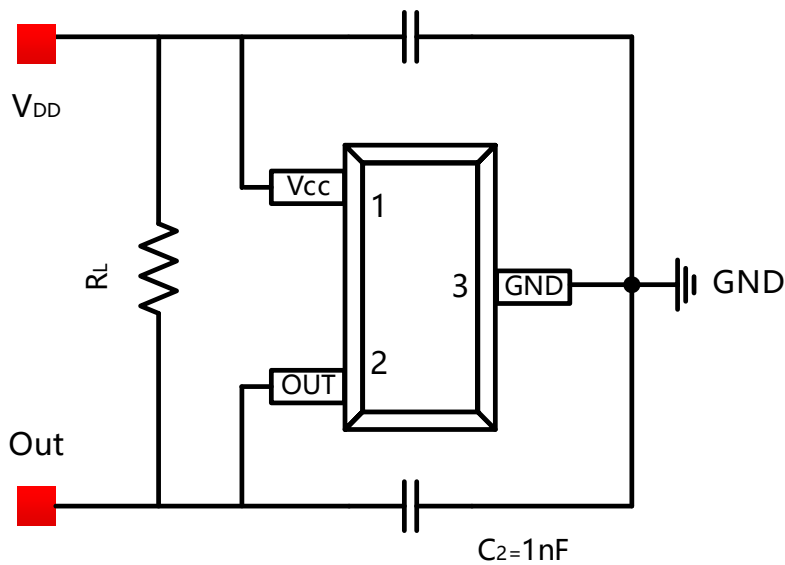

Figure.12 Typical Application Circuit (MT8911AT as example)

10 Self-diagnosis

The MT891X family offers self-diagnosis function during the sensor power-on. This allows the user to check the functionality of the whole signal path in response to BOP and BRP, as well as the wire connections of the sensor IC.

In order to activate the self-diagnosis function, user are advised to connect their system as shown in Figure.5, in which a host is required to control the VDD and Out port of the sensor. Then user should follow the following two steps:

Firstly the host has to power off the sensor and the host I/O pull the sensor output low.

Then the host powers on the sensor, and the host I/O has to release the Out afterwards. Referring to the self-diagnosis timing diagram in Figure.6, there is a minimum time interval between t_{sup} (the moment when V_{SUP} has reached 90% of its final value) and t_{rls} (the moment when host I/O releases).

If any one of the 2 criteria above is violated, the sensor might skip the self-diagnosis phase and enter the normal operation mode.

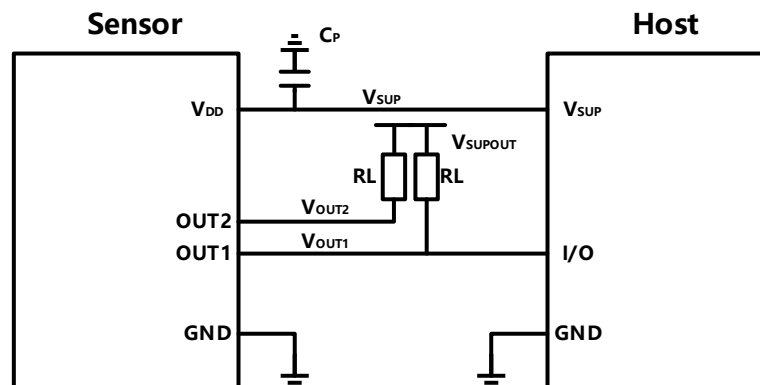

Figure.13 Sensor-Host connection diagram for self-diagnosis function (MT8911AT-Dual as example)

10 Self-diagnosis (Continued)

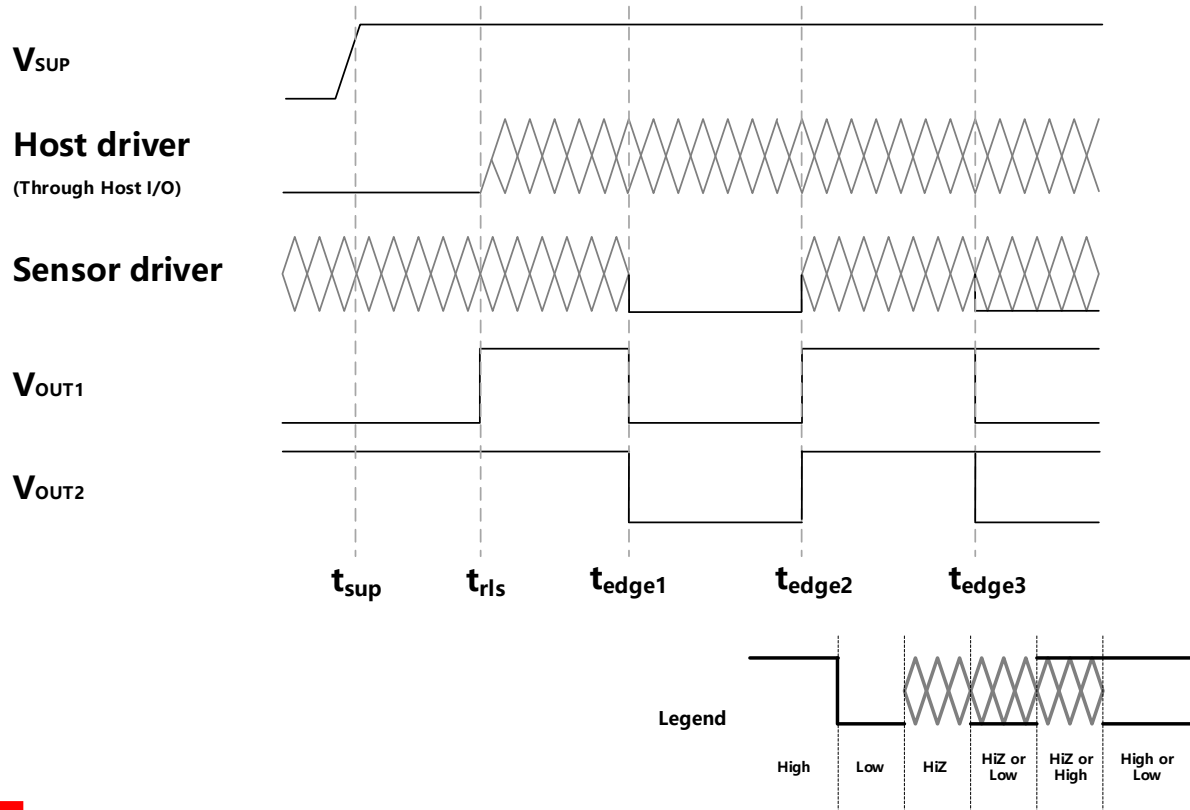

Figure.14 Self-diagnosis timing diagram (MT8911AT-Dual as example)

If the self-diagnosis function is activated, firstly the V_{OUT1} or V_{OUT2} will be pulled high by RL since host I/O has released. Then the sensor will generate a first dummy signal that drives the output low, which simulates an BOP. The falling edge (t_{edge1}) of V_{OUT1} or V_{OUT2} will be captured by the host. Afterwards the sensor generates a second dummy signal of the opposite polarity that drives the output high (by RL), which simulates an BRP. The rising edge (t_{edge2}) of V_{OUT1} or V_{OUT2} is also captured by the host. Now the self-diagnosis phase has ended and then the sensor will enter its normal operation mode, sending the first real data to V_{OUT1} or V_{OUT2} at t_{edge3} .

The two captured edges (t_{edge1} and t_{edge2}) should fall in a certain time window, specified in the table "Spec for self-diagnosis". This could be a criterion for host to determine whether or not the self-diagnosis has succeeded.

Spec for self-diagnosis

Symbol	Parameters	Min	Typ	Max	Unit
t_{rls}	Host I/O release time	$t_{sup} + 20^{(1)(2)}$	-	-	us
t_{edge1}	First falling edge of V_{OUT} during self-diagnosis	$t_{rls} + 5$	$t_{rls} + 10$	$t_{rls} + 15$	us
t_{edge2}	First rising edge of V_{OUT} during self-diagnosis	$t_{edge1} + 5$	$t_{edge1} + 10$	$t_{edge1} + 15$	us
t_{edge3}	First data available during normal operation	$t_{rls} + 15$	$t_{rls} + 30$	$t_{rls} + 45$	us
B_{detmax}	Maximum external field allowed during self-diagnosis	-	5000	-	Gauss

Notes:

- (1) t_{sup} is the time when sensor V_{DD} has reached 90% of its final value. $V_{DD} = V_{SUP}$.
- (2) Power-on of V_{DD} has to be faster than 5V/us.

11 Package Material Information (For Reference Only – Not for Tooling Use)

11.1 SOT-23 Package Information

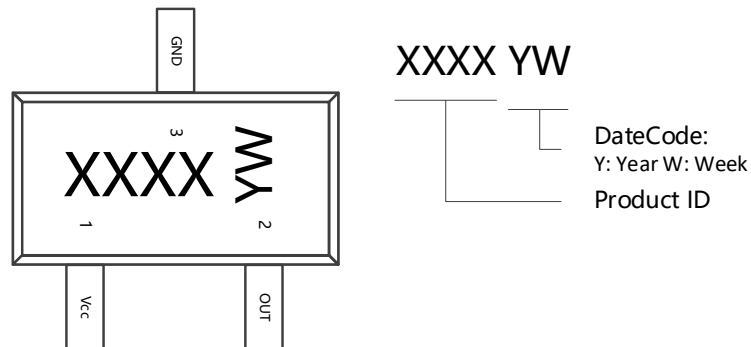

Figure.15 SOT-23 Chip Marking Spec

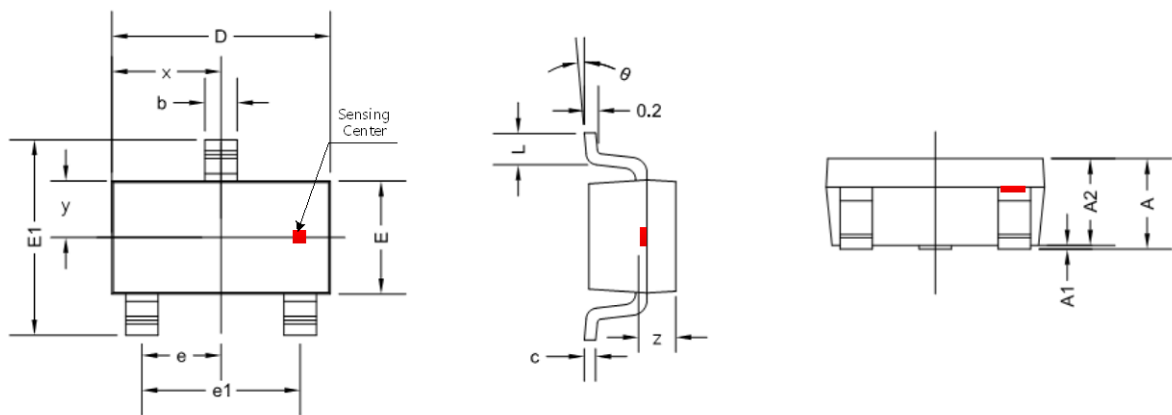

Figure.16 SOT-23 Package Drawing

Symbol	Dimensions in Millimeters		Dimensions in Inches	
	Min	Max	Min	Max
A	1.050	1.250	0.041	0.049
A1	0.000	0.100	0.000	0.004
A2	1.050	1.150	0.041	0.045
b	0.300	0.500	0.012	0.020
c	0.100	0.200	0.004	0.008
D	2.820	3.020	0.111	0.119
E	1.500	1.700	0.059	0.067
E1	2.650	2.950	0.104	0.116
e	0.950 TYP		0.037 TYP	
e1	1.800	2.000	0.071	0.079
L	0.300	0.600	0.012	0.024
θ	0 °	8 °	0 °	8 °

11 Package Material Information (For Reference Only – Not for Tooling Use)

11.2 SOT-23-6L Package Information

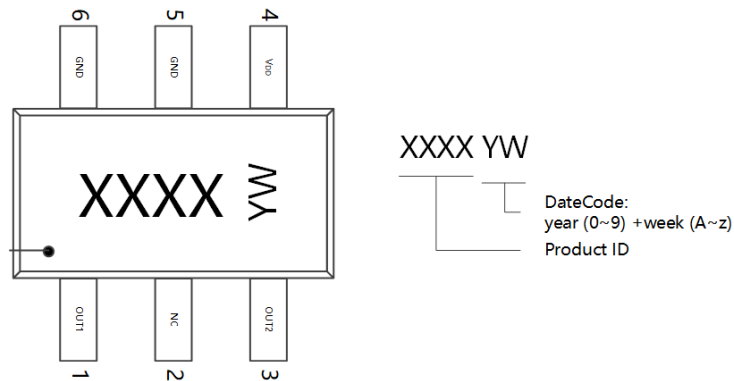

Figure.17 SOT-23-6L Chip Marking Spec

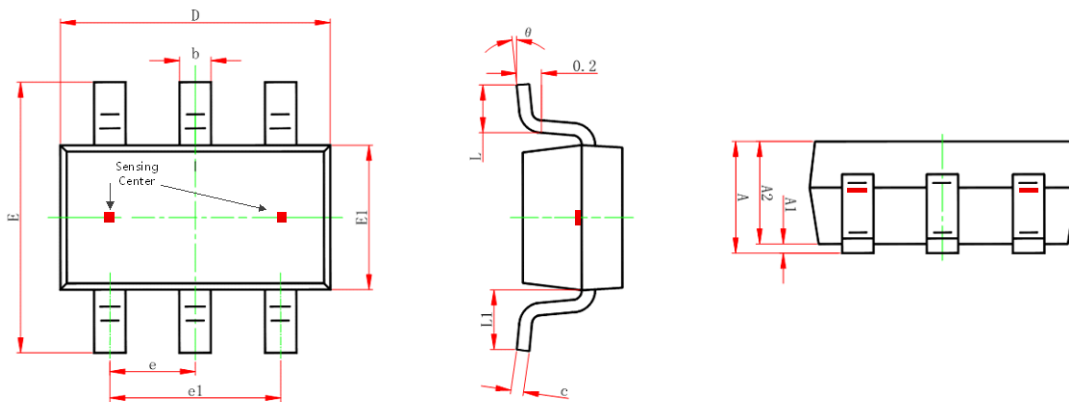

Figure.18 SOT-23-6L Package Drawing

Symbol	Dimensions in Millimeters		Dimensions in Inches	
	Min	Max	Min	Max
A	1.050	1.250	0.041	0.049
A1	0.000	0.100	0.000	0.004
A2	1.050	1.150	0.041	0.045
b	0.300	0.500	0.012	0.020
c	0.100	0.200	0.004	0.008
D	2.820	3.020	0.111	0.119
E1	1.500	1.700	0.059	0.067
E	2.650	2.950	0.104	0.116
e	0.950 TYP		0.037 TYP	
e1	1.800	2.000	0.071	0.079
L	0.300	0.600	0.012	0.024
L1	0.600 TYP		0.024 TYP	
θ	0 °	8 °	0 °	8 °

12 Copy Rights and Disclaimer

1. This document may not be reproduced or duplicated, in any form, in whole or in part without prior written consent of MagnTek . Copyrights © 2022, MagnTek Incorporated.
2. MagnTek reserves the right to make changes to the information published in this document at anytime without notice.
3. MagnTek' s products are limited for use in normal commercial applications. MagnTek' s products are not to be used in any device or system, including but not limited to medical life support equipment and system.

For the latest version of this document, please visit our website: www.magntek.com.cn